

XMM Mirror Module opto-environmental tests at CSL : A synthesis

Yvan Stockman, Claude Jamar, Jean-Phillippe Tock

Centre Spatial de Liège(CSL) - Université de Liège
Parc Scientifique du Sart-Tilman,
Avenue du Pré-Ailly, B-4031 ANGLEUR, BELGIUM
Phone : +32 4 367 66 68 ; Fax : +32 4 367 56 13 ;
Email : ystockman@ulg.ac.be Web site : <http://www.ulg.ac.be/cslulg>

Abstract

All XMM Mirror Modules (1 QM, 3 STM and 5 FM) were extensively tested in the Centre Spatial de Liège (CSL) facilities between 96 and 99. One Mirror Module consists in 58 Wolter I telescope shells co-aligned and co-focussed. To reduce straylight, an X-Ray Baffle is implemented in front of the Mirror Module entrance plane. To achieve spectral resolution in the 0.5 - 2.5 keV energy range a Reflecting Grating Assembly is added at the exit. All these subsystems were space qualified at CSL. To meet these requirements a new facility was built : FOCALX. This one provides full illumination collimated EUV beam, and partial illumination X-ray beams. This equipment is used for the optical and X-ray characterisation of each Mirror Module and sub-assemblies. Other CSL facilities were operated to create the environmental conditions (mechanical and thermal). This paper goes through the main salient features studied during the testing of the XMM Mirror Modules. It will present a general test philosophy and some conclusions that can be drawn from particular tests of the overall sequence. It will show that, at the end of a test campaign of a Mirror Module, all the critical parameters are well known and a large set of information is available for each Mirror Module integrated on the spacecraft. It will illustrate how to use this accumulated data for in-orbit image analysis. This will help the astronomical community to increase the understanding of the XMM recorded data, and by this way the knowledge of the X-ray universe.

Introduction

The high throughput X-ray spectroscopy mission XMM¹ (X-ray Multi mirror Mission) is the second cornerstone project of the ESA (European Space Agency) long-term programme Horizon 2000 for space science. It is due for launch in December 1999 by an Ariane 5 launcher on flight V04.

The scientific goal of the mission is the observation of point sources such as stars,

extended structures like supernova remnants or clusters of galaxies, and other diffuse but structured components, such as faint unresolved point sources or truly diffuse cosmic X-ray background.

To achieve these goals the XMM satellite includes 3 Mirror Assemblies (MA). Each MA consists in :

- A Mirror Module (MM) containing 58 X-ray optical quality Mirror Shell (MS),
- An X-ray Baffle (XRB) to reduce small angle straylight contribution in the focal plane,
- An entrance and exit baffle for suppression of wide angle straylight,
- An imaging detector.

Two of the three MA are equipped with a Reflection Grating Assembly (RGA) for spectral analysis. At the first diffraction order of each grating is placed 9 thinned back side illuminated CCD's working in counting mode.

Before launching such sophisticated telescope, it is mandatory to perform a correct certification and qualification on ground. It is necessary to confirm that optical performance is preserved under the hard space conditions and under all the environmental conditions that the telescope will undergo during his space life. An other major point for X-ray telescopes calibration is that it has to be performed on ground, since no cosmic X-ray source can be used as in-orbit calibration standards.

To achieve these ground calibrations, facilities are available. The well known in Europe are the Panter test facility of the MPE², and the CSL EUV³ vertical test facility in Liège. This last one has been built to compensate the lacks of the Panter one.

After a brief description of the XMM telescope, this paper reminds the reasons why the CSL tests facility has been built for the qualification of the XMM telescope. The test philosophy is exposed and the main results are reported.

XMM Mirror Module

The XMM Mirror Modules are the golden eyes of the mission⁴. These are grazing incidence type Wolter I telescope optimised to work in the 0.1 to

12 keV (12 to 0.1 nm). The main characteristics are given in the table I and an optical layout is illustrated in figure 1.

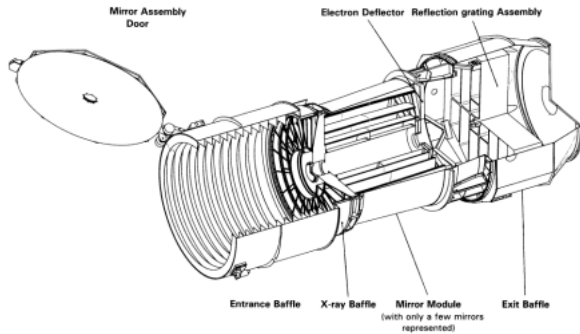

Figure 1 : Optical layout of an XMM MM

Focal length	7500 mm
Resolution	
Half Energy Width	16 arcsec (0.1 - 12 keV)
Full Width Half Max	8 arcsec (0.1 - 12 keV)
Effective area	1475 cm ² at 1.5 keV 580 cm ² at 8 keV
Reflective coating	Gold (250 nm)
Mirror diameter	
Outermost	700 mm
Innermost	306 mm
Axial parabola length	300 mm
Axial hyperbola length	300 mm
Mirror thickness	0.47 – 1.07 mm
Packing distance	1 – 5 mm
Numbers of mirrors	58
Mirror Module Mass	425 kg

Table I : Summary of the main characteristics of an XMM MM

Why a new facility ?

The particular design and size of the XMM X-ray optics do not allow to use an existing facility in 1993. The vertical bench at Brera using UV full-collimated beam limits the analysis because of diffraction. The MPE Panter Facility using a finite distance X-ray source limits the analysis mainly because one third of the MM is not correctly illuminated due to the slight divergence of the X-ray beam (figure 2). When the XRB is added, only a third of the mirror contribute to image in its focal plane. Test of the MM with the optical axis horizontal is not inconsequential for such thin mirror shells, parasitic gravity effects could not be exempted. These are unacceptable technical situations. The MPE test facility was also dedicated for the calibration of the XMM focal

plane cameras, that provided an unacceptable planning situation because of the large amount of tests to be performed on the MM. To solve these problems, ESA XMM Project decided in 1994 to complement the Panter facility by building a custom designed vertical facility. CSL was responsible to develop and qualify a dedicated test facility in a tight time schedule. The proposed solution is to use EUV light. At these wavelengths the diffraction effects are negligible. It is possible to use standard and available technologies. To reduce gravity impact on such thin MS, it is recommended to build the facility with the optical axis vertical. In December 93, it is decided to perform an horizontal EUV test in order to validate the concept of an EUV optical test of XMM MS. The promising results⁵ of this validation test led to the decision to build in Liège at CSL a dedicated facility to certify all the XMM MMs. The choice of CSL was logical due :

- Its world wide known experience in optical scientific payload testing,
- Its qualification as an ESA co-ordinated facility,
- The facilities for vibration and thermal vacuum testing are available on site, that limits the handling and transport of the telescope and saves time and money.

The kick off meeting took place in June 94. Eighteen months later (in February 96) the facility was accepted for the qualification and environmental tests of the MM Qualification Model. From 96 to beginning 99, 9 MM (1 QM, 3 STM and 5 FM) have been extensively tested at CSL.

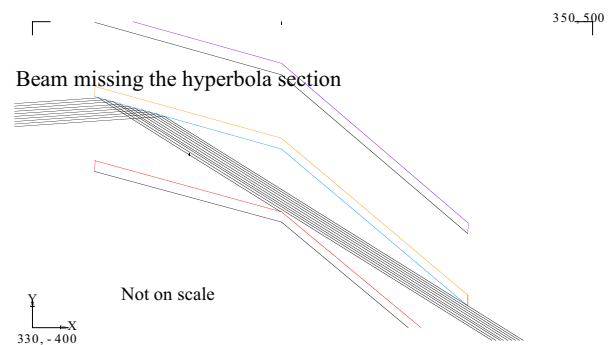

Figure 2 : Beam coming from a source 130 m away of the telescope entrance plane and missing the hyperbola section

CSL EUV vertical test facility

The EUV vertical test facility is illustrated in figure 3. The facility is described in details in many papers³. The main features are summarised in figure 3. The overall height of the facility is 30 m. It is composed of one main chamber of 12 m in height and 4.5 m in diameter, and 5 annexed vacuum chambers (3 for the sources and 2 for the collimators). The same interface structure as on the payload is used to fix the MM. This structure is mounted on a 5-axis motion system to allow the positioning and the alignment of the MM in front of each channel. In the focal plane, 3 detectors are available to record the signal. All of them are on a 3-axis translation system to place each of the detectors in the MM focal plane, when used in front of any of the channels. In order to simulate a far off-axis source, it is possible to tilt the whole optical bench and detectors support structure from -2 to 7.5 degrees. This was a very useful function for the characterisation of the XRB.

FOCAL X is located in a $28*18*15$ m₃ class 10000 cleanroom and a dedicated class 100 has been built around the chamber.

The facility is able to accomodate different types of XMM test articles :

- single mirror shell on a rigid interface,
- single mirror shell hanging on the suspension device,
- bare mirror module,
- mirror module equipped with an XRB, an RGA and an EXB (Exit Baffle).

Each of the three channels can be used independently from the other ones.

The three beam channels are :

An *EUV collimator* providing a full vertical collimated illumination of the MM entrance plane. An Electron Resonance EUV source fed with He, emits the He I α and He II α lines at 58.4 and 30.4 nm respectively. This source illuminates a pinhole placed at the focus of a Cassegrainian collimator. The Cassegrainian design was preferred for thermo-mechanical stability reasons. The primary and secondary mirrors are polished with a RMS microroughness better than 1 nm to reduce scattering and are Pt coated to obtain good reflectivity in the EUV. The collimated beam after crossing the telescope, focalises on a thinned backside illuminated CCD detector. A set of filters is available to select several wavelengths.

An *X-ray grid collimator* provides an X-ray pencil beam of 500 μ m diameter at telescope entrance plane. This is achieved thanks to a classical X-ray electron impact point source providing spectral lines between 1 and 15 keV. Two pinholes of 300 μ m diameter separated by 7500 mm are the only optical components of this channel. In the telescope focal plane two detectors are available : one front side CCD detector for imaging purposes and one Ge crystal detector for spectral purposes.

An *X-ray partial collimator* provides a collimated beam of 8 x 50 mm₂. The main optical component of the channel is an off axis parabola mirror of 1 m length with low slope errors. The mirror is gold coated. This design has been selected because of the high image quality of the XMM MM, and the possibility to achieve a compact design. The same type of X-ray source and the same X-ray detectors as for the grid collimator are employed.

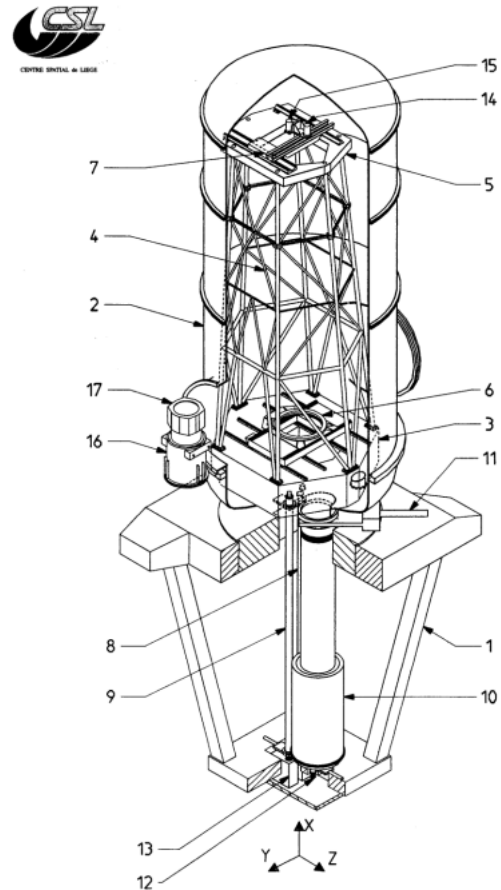

1. Seismic block, 2. Vacuum vessel, 3. Optical bench, 4. Tower, 5. Detector optical bench, 6. Specimen mechanisms, 7. Detectors mechanisms, 8. X collimated beam, 9. X pencil beam, 10. EUV channel, 11. Valve, 12. EUV source, 13. X-ray sources, 14. EUV detector, 15. X-ray detectors, 16. MASP, 17. Telescope

Figure 3 : CSL EUV vertical test facility general layout

Test philosophy

The test philosophy is fairly simple : each MM is tested at CSL to establish the optical performance after manufacturing. The optical performance evaluated in the CSL facility are :

With the EUV collimator :

- The Point Spread Function.
- The focal length.
- The intra and extra focal images for diagnostic purposes.
- The effective area in EUV mainly for contamination monitoring.

With the X-ray grid collimator :

- The MS position in the MM.
- The reflectivity and the deduction of the X-ray effective area.
- The angle resolved scattered for the surface roughness monitoring.

This test sequence is followed by the environmental tests consisting in :

1. Vibration tests to simulate the launch conditions.
2. Thermal test to simulate the in orbit space conditions.

The same set of optical measurements is repeated after these environmental tests to confirm the integrity of the optical performance.

The MM is then sent to the MPE for X-ray calibration, to check the mirror status, assessing the X-ray performance and calibrating the telescope in terms of PSF and effective area.

The MM comes back to CSL for the XRB integration. The same test philosophy is followed to verify the correct design, manufacturing, integration and alignment of the XRB, and the invariance of the optical performance under the same environmental simulated conditions as earlier exposed. The optical sequence monitor mainly :

- The non degradation of the on axis optical performance in terms of PSF and effective area in the EUV and in the X-ray.
- The correct alignment of the XRB with the help of off axis vignetting and pencil beam measurements.
- The XRB efficiency and comparison to the predicted model.

Once the XRB are integrated on the MM, for two of the 5 flight MM, a reflecting Grating Assembly (RGA) is mounted. The EUV collimated beam is used to verify :

- The correct alignment of the RGA.
- The determination of the PSF at the telescope focus and at zero order diffraction focus.
- Extra focal images for diagnostic purposes.
- The image quality in the FOV.
- The determination of straylight level and behaviour at the first order diffraction focus where the RGA focal plane camera will be placed and at telescope focus.

Partial EUV illumination tests are used to control the RGA grating stack orientation.

The X-ray collimator or the pencil beam are used to evaluate the grating efficiency and the first and second diffraction order position.

The flow chart of figure 4 summarises the MM test philosophy.

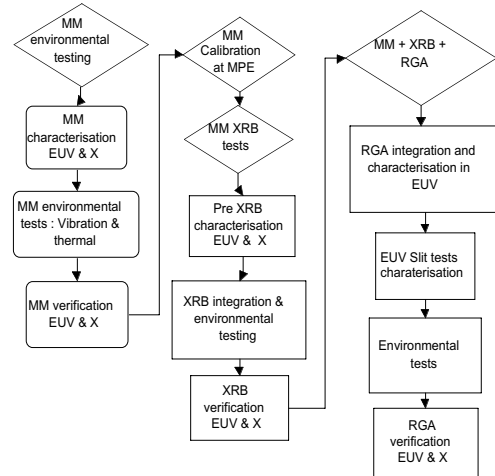

Figure 4 : MM test plan

EUV collimator test results

The classic EUV results are the best focus PSF of the MM at 58.4 nm. This PSF provides the geometrical optical performance of the MM. The advantages of using EUV are that the image is not degraded by diffraction neither by scattering. So this image is strictly representative of the shape quality of the mirrors. Any deviation of the shape of a MS can be detected with this data. An obvious example is the image recorded during the RGA2 on FM2 MM⁶.

Detailed observation of the 0-order focus (figure 5 a and b) shows that there is a slight change between image before and after environmental test. The tail going along $-Z$ is decreasing. Explanation of this improvement is provided by the analysis of the extrafocal images (figure 6), where the orientation of the grating stacks is easily observed. The 0-order pre-environmental extra focal image detected the mis-aligned grating stacks T2-2 (lower left) and T4-6 (central up right). The impact of this mis-aligned stack represents only 0.5 % in terms of energy (1 over \approx 200 stacks). After the environmental test the T4-6 is aligned when the T2-2 stays mis-aligned. This realignment improves the 0-order best focus image.

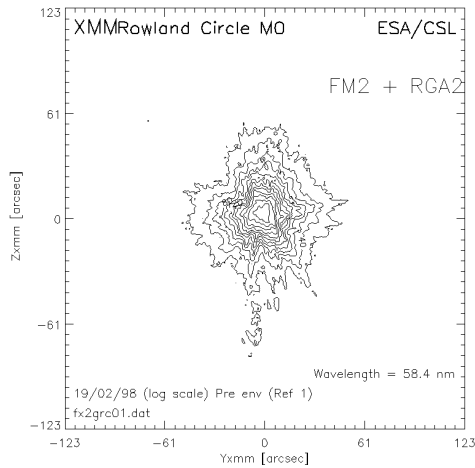

Figure 5.a : FM2 Best focus at 0-order diffraction before environmental test

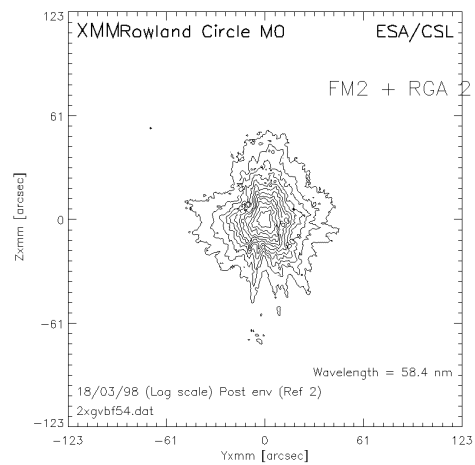

Figure 5.b : FM2 Best focus at 0-order diffraction after environmental test

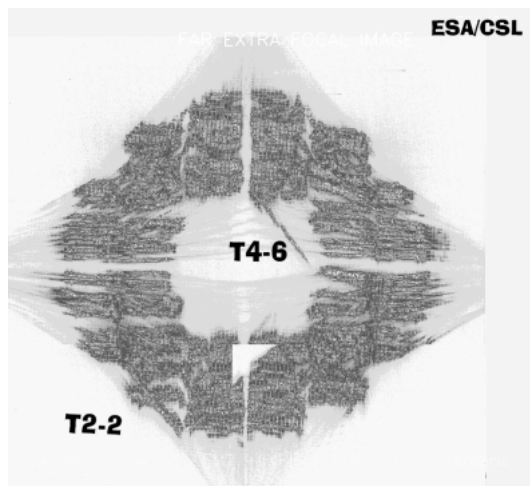

Figure 6 : Extra focal image of FM2 MM with RGA2 EPIC focus

PSF data is very useful to improve the numerical model⁷. This model is needed to generate the

telescope calibration database essential for the astronomers. The model is generated from the metrological data recorded on each MS at manufacturer premises before the integration of the MS in the MM. The comparison between the simulated image and the EUV image show slight differences mainly due to the integration of the spacecraft interface structure which is not included in the numerical model⁸. To integrate these effects in the model two ways are followed :

- Deconvolution between simulated image and experimental image. This provides a library with the deformation function. The major problem of this alternative, is that it requires computing time and space memory.
- Parameterisation of the measured PSF by three 2D Gaussian functions, one for the core, one for the mid shape of the PSF and one for the wings, combined with a $\cos(3.\theta)$ for the triangular shape and a $\cos(16.\theta)$ for the spider enhancement contribution.

These ways give good results, but the second one presents the best performance, including in restoration problems: even distortion can be precisely calibrated. The parameterisation method has been developed with on-ground images, and they are representative of the geometrical performance for energies lower than 2 keV. The method can be extrapolated to all the energies, integrating other function such as a negative exponential to modelise scattering.

X-ray grid collimator test results

The main results achieved with the X-ray⁹ pencil beam are : the effective area and the wing scattering.

The effective area is computed from the reflectivity measurements. The intensity measured at solid state detector level corresponds to the intensity of the beam reflected consecutively on the parabola and hyperbola section. This intensity is divided by the measured direct flux obtained once the MM is out of the beam. This computation is accomplished at 1.5, 2.1, 2.2, 8.0, 8.9, 9.7, 11.5 keV on all the MS. This provides a sample of reflectivity data (two reflections) over the spectral working range of XMM. Using the reflectivity values corrected by the scattering (because of the limited size of the detector), it is possible to evaluate the effective area of a MM, using the following formula:

$$Eff_area = \sum_{i=1}^{58} R_i * Geom_area_i$$

where R_i is the measured reflectivity (Parabola + hyperbola) and $Geom_area_i$ is the designed geometrical area of the i^{th} MS taking into account the spider shadowing. Example of this computation done for all the MM is presented in figure 7. These simple measurements are fairly

good compared to more sophisticated ones performed at the MPE.

X-ray scanning collimator results

The X-ray collimator was first dedicated to achieve the PSF at high energies (larger than 3 keV). However enough data were available with the EUV beam tests and the MPE finite distance X-ray source tests. The main missing characterisation was the effective area calibration over the full

XMM spectral range. This was mainly achieved⁹ with a Carbon anode, providing a continuum spectrum in the energies of interest, and the use of the solid state detector to allow the spectral resolution. The figure 6 presents the results achieved on MM FM3, and show good correlation between the expected values from the model the pencil beam values and the X-ray collimator results.

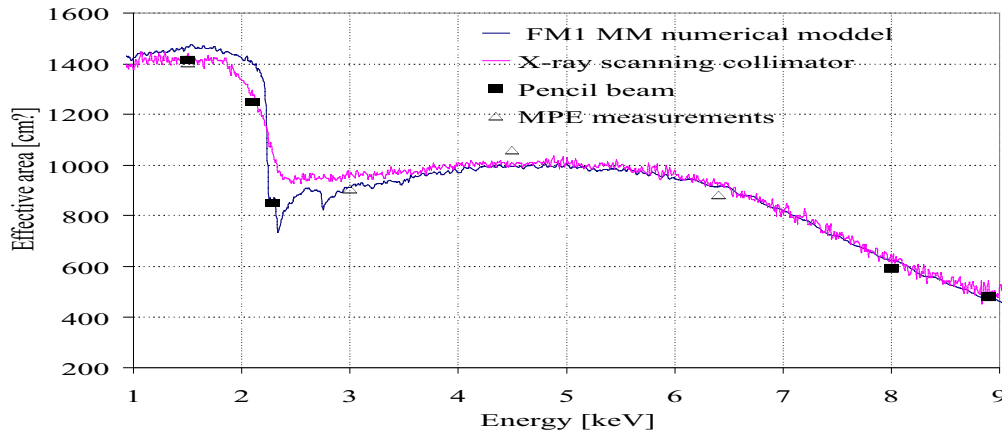

Figure 7 : Comparaison of effective area measurements on MM FM3

Conclusions

The optical performance of an X-ray telescope can be fully determined in the CSL vertical EUV facility. The EUV collimator gives the geometrical properties, and the X-ray collimators provide the radiometric performance of an X-ray telescope. All the flight MM have extensively been tested in this facility and all the required environmental have been performed at CSL.

Acknowledgements

The authors are grateful to all CSL staff who worked days and nights to provide all these useful and high quality data to perform this work. The vertical facility at CSL was funded by ESA XMM project under the contract number 9939/92/NL/PP. The XMM FM MM mirrors were replicated and integrated by MEDIA LARIO under ESA contract number 0545/93/NL/RE.

References

1. D. Lumb, H. Eggel, R. Lainé, A. Peacock, "X-ray Multi-Mirror Mission - an overview", SPIE **2808**, Denver 1996.
2. <http://www.panther.mpe-garching.mpg.de>
3. J.Ph. Tock, I. Domken, J.P. Macau, Y. Stockman, M. Thomé, J. Jamar, Ph. Kletzkine, "Status of XMM Test Programme in CSL EUV and X-ray Test Facility (FOCAL X)", First XMM Workshop at ESTEC, Noordwijk 98
4. D. de Chambure, R. Lainé, K. van Katwijk, J. van Casteren & P. Glaude, "Producing the X-

Ray Mirrors for ESA's XMM Spacecraft", ESA bulletin **89**, February 1997.

5. O. Citterio, P. Conconi, M. Ghigo, C. Jamar, R. Loi, F. Mazzoleni, G. Naletto, E. Pace, Y. Stockman, G. Tondello, P. Villoresi, "Vertical test Facility operating at vacuum ultraviolet for testing very thin wall grazing incidence X-ray mirrors", SPIE **2279**, San Diego 1994.
6. Y. Stockman, I. Domken, H. Hansen, J.Ph. Tock, T.A. Decker, A. Rasmussen, T. den Boggende, J.W. den Herder, G. Bagnasco, D. de Chambure, C. Erd, Ph. Gondoin, "XMM Flight Mirror Module with Reflection Grating Assembly and X-ray baffle testing", SPIE **3445**, San Diego 1998.
7. Ph. Gondoin, B. Aschenbach, M. Deijjeysbergen, R. Egger, F. Jansen, Y. Stockman, J.P.Tock, "Calibration of the first XMM Flight Mirror Module I - Image quality", SPIE **3444**, San Diego 1998.
8. Y. Stockman, Y. Houbrechts, Y. Nazé, P. Rochus, J. Ph. Tock, P. Gondoin "PSF modelling of the XMM Flight Mirror Modules", SPIE **3765**, Denver 1999.
9. Y. Stockman, H. Hansen, Y. Houbrechts, J. Ph. Tock, D.de Chambure, P. Gondoin, "XMM Flight Mirror effective area", International Symposium on Optical Systems Design and Production, Berlin 1999.